

11 RIBBON CABLE ASSEMBLIES

11.1 Jacketed / Round 16-Pin Ribbon Cable (Nominal 18" Length)

Lumenetix part #:
28.700.003.03

16-pin Tyco Connector at one end, 20-pin JST connector at other end; for connecting ALM to round array.

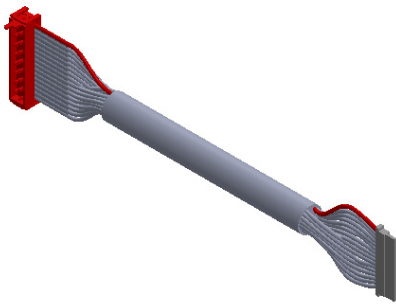
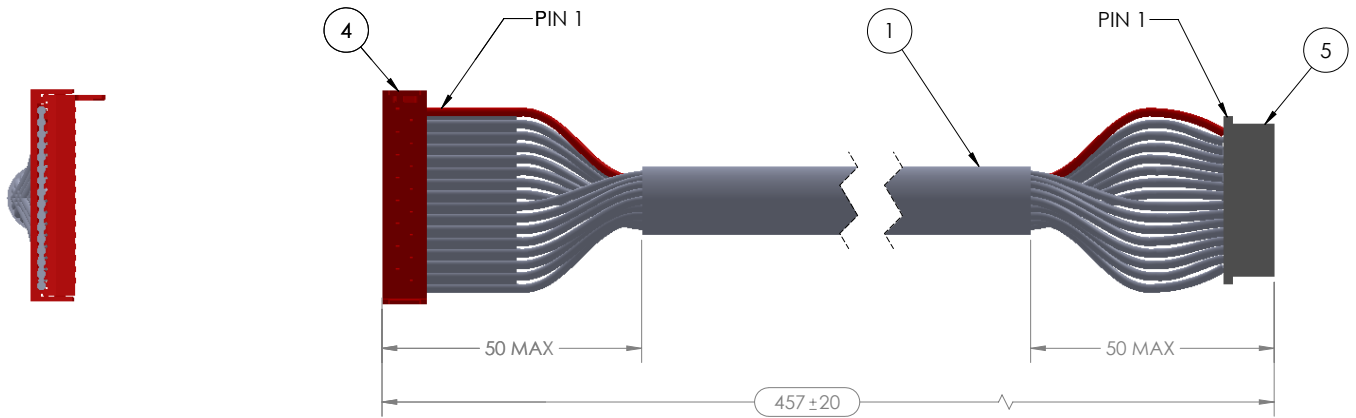

Note: All dimensions are in millimeters.

ITEM NO.	PART NUMBER	DESCRIPTION	QTY.
1	3M ROUND JACKED FLAT CABLE	3M ROUND JACKED FLAT CABLE 3759/16	1
2	CRIMP SSSL-003T-P0.2		16
4	16 PIN CONNECTOR c-1-215083-6-t-3d	CONNECTOR 16 PIN 1-215083-6	1
5	JST-SHLP-16V-S-B		1

11 RIBBON CABLE ASSEMBLIES

11.2 Flat 16-Pin Ribbon Cable (Nominal 18" Length)

Lumenetix part #:
 28.700.001.05

16-pin Tyco Connector at one end, 20-pin JST connector at other end; for connecting ALM to round array.

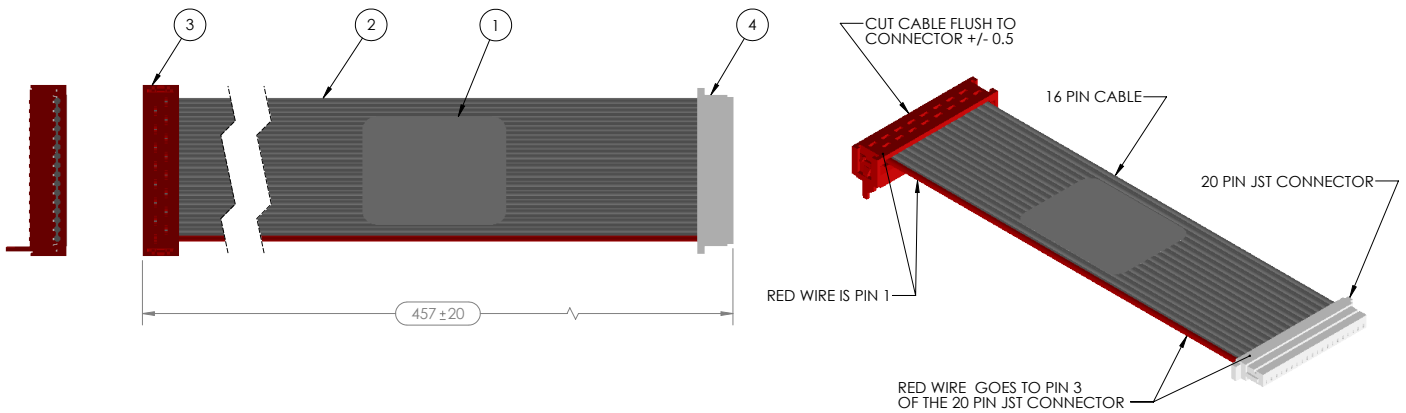

Note: All dimensions are in millimeters.

1	LABEL, LUMENETIX, PART#, DESCRIPTION, REVISION	1
2	16 PIN RIBBON CABLE 3M 3365-16	1
3	16 PIN CONNECTOR c-1-215083-6-t-3d	1
4	460.042 CONNECTOR SHR-20V-S-B	1
5	CRIMP SSH-003T-PO-2	16