

10 SECONDARY OPTICS

10.1 Attaching Compatible Reflectors for Round LED Arrays

The tunable color round LED arrays with 19mm LES (Light Emitting Surface) accept twist-to-lock reflectors with an attachment collar. The fastener specifications are shown in the following table while mounting hole locations are shown in Figures 1, 2 and 3.

CTM One Secondary Optics Fastener Specifications

Attachment Type	Fastener specifications	Screw length	Notes
Twist-Lock (with Adaptor Ring)	M3 x 6; quantity of two	6 mm (1/4")	Pan head screws
Twist-Lock (with Adaptor Ring & Adaptor)	M3 x 6; quantity of two	6 mm (1/4")	Pan head screws
TE Type 2 Clip	M3 x 10; quantity of two	10 mm (3/8")	Rounded head screws

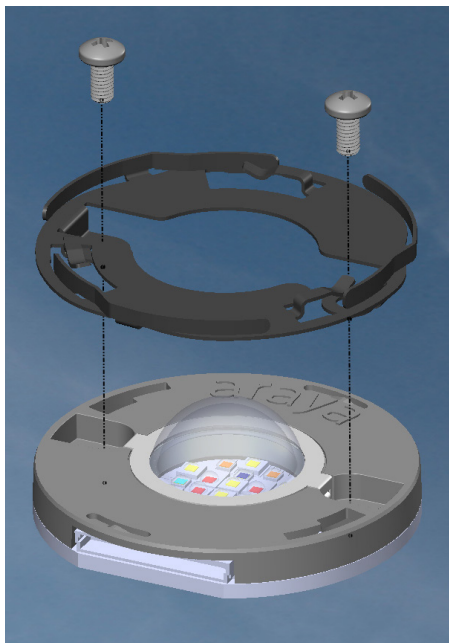

Figure 1: Round LED Array with XSA-242 Adaptor Ring (by Xicato)

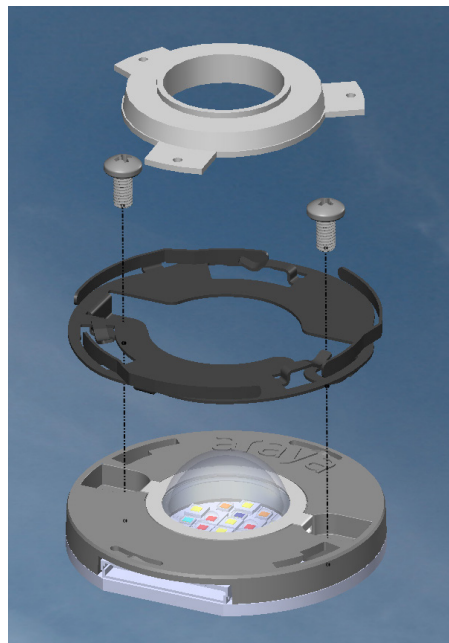

Figure 2: Round LED Array with XSA-242 Adaptor Ring (by Xicato) with Adaptor, used for Reflectors by Diffractive Optics (p/n: P14008) or Khatod (p/n: KE1950W)

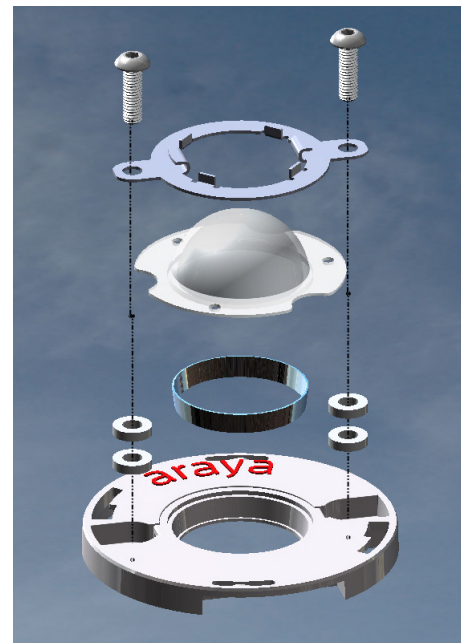

Figure 3: Round LED Array with Lumawise Z50 Type 2 Clip (by TE)

10 SECONDARY OPTICS

10.2.1 Compatible Reflectors List

Compatible Reflectors for 19mm LES round LED arrays (continued on next page)

Manufacturer	M. Part Number	beam angle (deg)	outer dim (mm)	height (mm)	optical finish	optical finish 2	attach method
Diffractive Optics	P13302 (XSA-220)	40	50	29	specular	none	XSA242
Diffractive Optics	P13004 (XSA-221)	40	49.3	28.6	specular	faceted	XSA242
Diffractive Optics	P13008 (XSA-223)	40	54.1	42.3	specular	none	XSA242
Diffractive Optics	P13010 (XSA-224)	20	70	42	specular	none	XSA242
Diffractive Optics	P13016 (XSA-227)	20	94.3	83	specular	faceted	XSA242
Diffractive Optics	P13825	10-15	69	33	specular	superfacet, diamond	XSA242 + P14008
Diffractive Optics	P13827	20	69	33	specular	superfacet, diamond	XSA242 + P14008
Diffractive Optics	P13829	30	69	33	specular	superfacet, diamond	XSA242 + P14008
Diffractive Optics	P13765	10-15	75	42.3	specular	superfacet, diamond	XSA242 + P14008
Diffractive Optics	P13767	20	75	42.3	specular	superfacet, diamond	XSA242 + P14008
Diffractive Optics	P13831	30	75	42.3	specular	superfacet, diamond	XSA242 + P14008
Diffractive Optics	P13769	10-15	85	43.3	specular	superfacet, diamond	XSA242 + P14008
Diffractive Optics	P13771	20	85	43.3	specular	superfacet, diamond	XSA242 + P14008
Diffractive Optics	P13833	30	85	43.3	specular	superfacet, diamond	XSA242 + P14008
Diffractive Optics	P13773	10-15	92	43.3	specular	superfacet, diamond	XSA242 + P14008
Diffractive Optics	P13775	20	92	43.3	specular	superfacet, diamond	XSA242 + P14008
Diffractive Optics	P13781	30	92	43.3	specular	superfacet, diamond	XSA242 + P14008
Diffractive Optics	P13713	20	75	37	specular	faceted	XSA242 + P14008
Diffractive Optics	P13715	35	75	37	specular	faceted	XSA242 + P14008
JORDAN	11324 10 10101	25	111	66	specular	super facet	none
JORDAN	11324 00 10101	40	111	66	specular	super facet	none
Khatod EASY	KCLP 1858CR	12	72	52	combination	none	Zhaga Screw 35mm
Khatod EASY	KCLP 1858ME	30	72	52	honeycomb lens	none	Zhaga Screw 35mm
Khatod EASY	KCLP 1858WI	50	72	52	bugeye lens	none	Zhaga Screw 35mm
Khatod EASY	KCLP 1859CR	12	110	61	combination	none	Zhaga Screw 35mm
Khatod EASY	KCLP 1859ME	30	110	61	honeycomb lens	none	Zhaga Screw 35mm
Khatod EASY	KCLP 1859WI	50	110	61	bugeye lens	none	Zhaga Screw 35mm
Khatod EASY	KCLP 1799 CR	asym			specular	none	Zhaga Screw 35mm
Khatod	KCLP 1682 CR (1429CR)	11	65	35	specular	none	TE Type II / XSA242 + KE1950W
Khatod	KCLP 1682 ST (1429ST)	20	65	35	diffuse	none	TE Type II / XSA242 + KE1950W
khatod	KCLP 1683 CR (1430CR)	26	65	35	specular	none	TE Type II / XSA242 + KE1950W
khatod	KCLP 1683 ST (1430ST)	24	65	35	diffuse	none	TE Type II / XSA242 + KE1950W
khatod	KCLP 1431 CR		65	35	specular	none	TE Type II / XSA242 + KE1950W
khatod	KCLP 1432 CR		65	35	specular	none	TE Type II / XSA242 + KE1950W
khatod	KCLP 1685 ST (1432ST)	32	65	35	diffuse	none	TE Type II / XSA242 + KE1950W
khatod	KCLP 1684 ST	28	65	35	diffuse	none	TE Type II / XSA242 + KE1950W
khatod	KCLP 1686 CR	44	65	35	specular	none	TE Type II / XSA242 + KE1950W
khatod	KCLP 1687 CR	27	65	35	specular	none	TE Type II / XSA242 + KE1950W
khatod	KCLP 1687 ST	31	65	35	diffuse	none	TE Type II / XSA242 + KE1950W
khatod	KCLP 1688 CR	37	65	35	specular	none	TE Type II / XSA242 + KE1950W
khatod	KCLP 1688 ST	38	65	35	diffuse	none	TE Type II / XSA242 + KE1950W
khatod	KCLP 1689 ST	42	65	35	diffuse	none	TE Type II / XSA242 + KE1950W
khatod	KCLP 1690 ST	50	65	35	diffuse	none	TE Type II / XSA242 + KE1950W
khatod	KCLP 1691 ST	56	65	35	diffuse	none	TE Type II / XSA242 + KE1950W
khatod	PLJT 1866	n/a			diffuse ball		XSM242

NOTE: Reflectors have been recommended based on independent optical tests conducted by Lumenetix, and should be used as guidelines.

Final reflector evaluation should be made by fixture manufacturers with all optics in place.

10 SECONDARY OPTICS

10.2.2 Compatible Reflectors List

Compatible Reflectors for 19mm LES round LED arrays (continued from previous page)

Manufacturer	M. Part Number	beam angle (deg)	outer dim (mm)	height (mm)	optical finish	optical finish 2	attach method
Nata	3990-E	24	75	43	diffuse	super facet	none
Nata	3991-E	36	75	43	diffuse	super facet	none
Nata	3993-E	40	85	50.5	diffuse	super facet	none
Nata	2-1050A	25	65	44	satın	none	XSA242
Nata	2-1131E	18	68	51	m-diffuse	facets	XSA242
Nata	2-1132E	30	68	51	m-diffuse	super facet	XSA242
Nata	2-1133E	45	68	51	m-diffuse	super facet, flare	XSA242
Nata	4-1150E5	39	111	65	m-diffuse	super facet	none
Nata	4-1405E	16	98	66.4	specular	facets	none
Nata	4-1406E				diffuse	super facet	none
Nata	2-1535E				m-diffuse	super facet	none
Nata	4-1536E	20	110	65.3	m-diffuse	super facet	none
Nata	4-1537E	30	110	62	diffuse	super facet	none
Nata	4-1664E	24	111	65	m-diffuse	super facet	none / 3 tabs
Nata	4-1666E	38	111	65	diffuse	super facet	none / 3 tabs
Nata	4-1667E	45	111	61.3	m-diffuse	super facet	none
Nata	4-1820E	60	111	65	diffuse	super facet	none / 3 tabs
Nata	3-1901M	28	79	51	m-diffuse	super facet	XSA242
Nata	3-1903M	40	79	51	m-diffuse	super facet	XSA242
Nata	4-1966E	7	111	65	m-diffuse	super facet	XSA242
Widegerm	1009T-XC	38	49	30.5	specular	faceted	XSA242
Widegerm	1010T-XC	55	50	30.5	specular	none, trumpet	XSA242
Widegerm	208x-XM		71.5	54	satın	lightfaceted	XSA242
Widegerm	2201T-XM	19	72	44	m-diffuse	faceted	XSA242
Widegerm	2202T-XM	35	72	44	m-diffuse	faceted	XSA242
Widegerm	3150T-XM	17	75	48	m-specular	faceted	XSA242
Widegerm	3204T-XM	27	82	46	m-diffuse	faceted	XSA242
Widegerm	3205T-XM	36	82	46	specular	faceted	XSA242
Widegerm	3207T-XC	-	82	46	satın	none	XSA242
Widegerm	4219T-XM	20	111	36	diffuse	faceted	XSA242
Widegerm	4220T-XM	37	111	36	m-specular	faceted	XSA242
Widegerm	4221T-XM	47	111	36	m-specular	faceted	XSA242
Widegerm	4301T-XM	36	111	69	m-diffuse	faceted	XSA242
Widegerm	4401T-XM	43	111	69	m-diffuse	faceted	XSA242

NOTE: Reflectors have been recommended based on independent optical tests conducted by Lumenetix, and should be used as guidelines. Final reflector evaluation should be made by fixture manufacturers with all optics in place.