

10 WIRING DIAGRAMS

10.1 0-10V Control of Dimming

0-10V Dimming Control Only. Remove power from the DDM. Connect a 0-10V control device to violet (+) and gray (-) wires. When the DDM is powered up, the 0-10V control device will adjust Dimming from 100-1%. Preset controls are not available in this configuration.

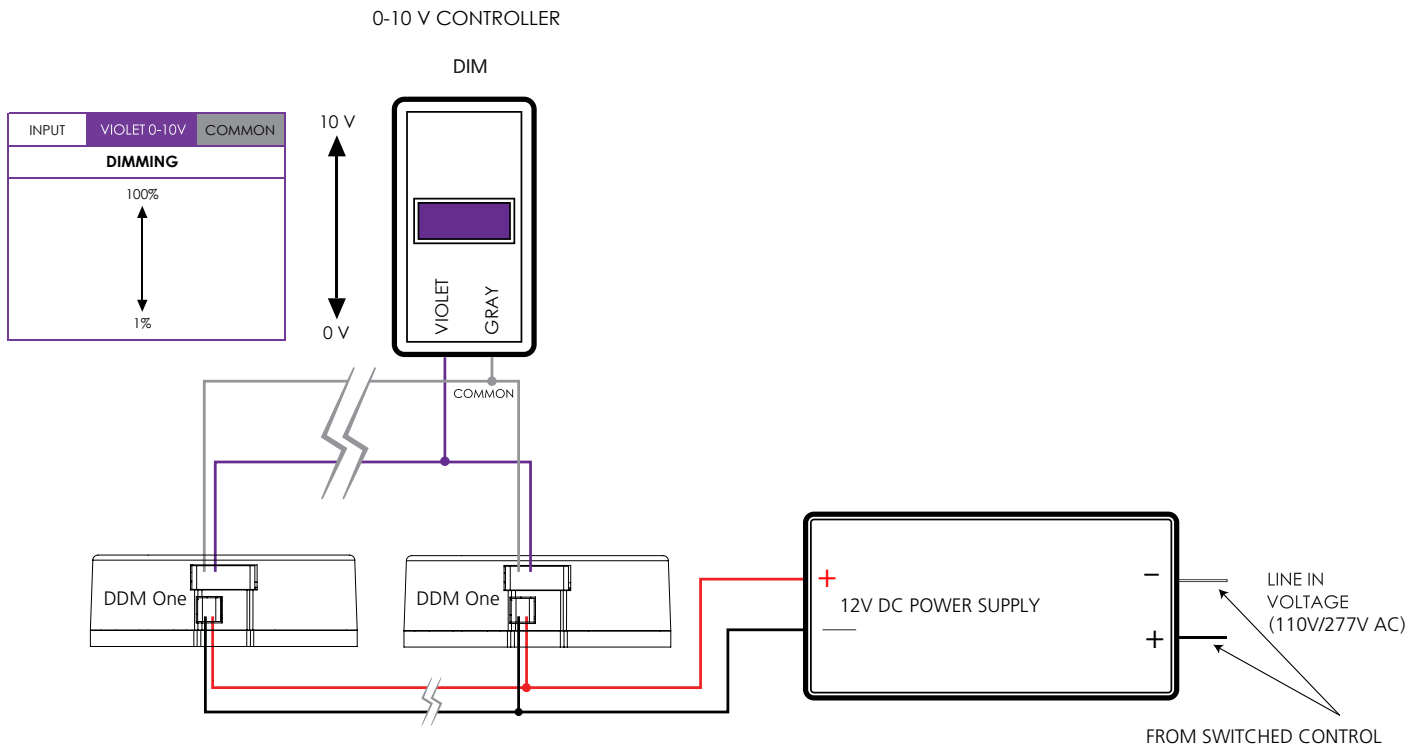

Lead Color and Input

Lead Color	Input
Red	Power 12V DC (+)
Black	Power Common (-)
Violet	0-10V Dimming (+)
Gray	Signal Common for 0-10V Dimming (-)

Notes:

1. DDM sources current to 0-10V control at 0.2mA nominal capacity.
2. Only pins 1 and 6 are used in the control cable assembly.

Lumenetix part #s:
28.002.001.01 (power cable assembly)
28.002.002.01 (control cable assembly)

10 WIRING DIAGRAMS

10.2 EcoSystem Input / Lux Output (12V DC) Digital Control Adapter

Notes:

1. 12V power (red/black) is Class-2 rated.
2. Module Data +/- (white with orange stripe/orange) to araya⁵ modules is Class-2 rated.
3. Adapter is configured at factory for EcoSystem inputs.
4. DCA may be installed in the luminaire or at the control system.
5. One EcoSystem address (1 channel for warm-dim) per DDM module/DCA kit.
6. EcoSystem Channel 1 is always Intensity Level. EcoSystem Channel 2 is always CCT Preset.
7. In the EcoSystem programming mode, EcoSystem Channel 1 (Intensity Level) will cycle through the dimming range (100%-1%) to identify channel. EcoSystem Channel 2 (CCT Preset) will cycle through the CCT range of the module to identify channel.
8. CAUTION: The power cable should ONLY be plugged into the 2-pin power receptacle provided. Insertion of the cable into any other slot will damage the Digital Control Adapter unit.

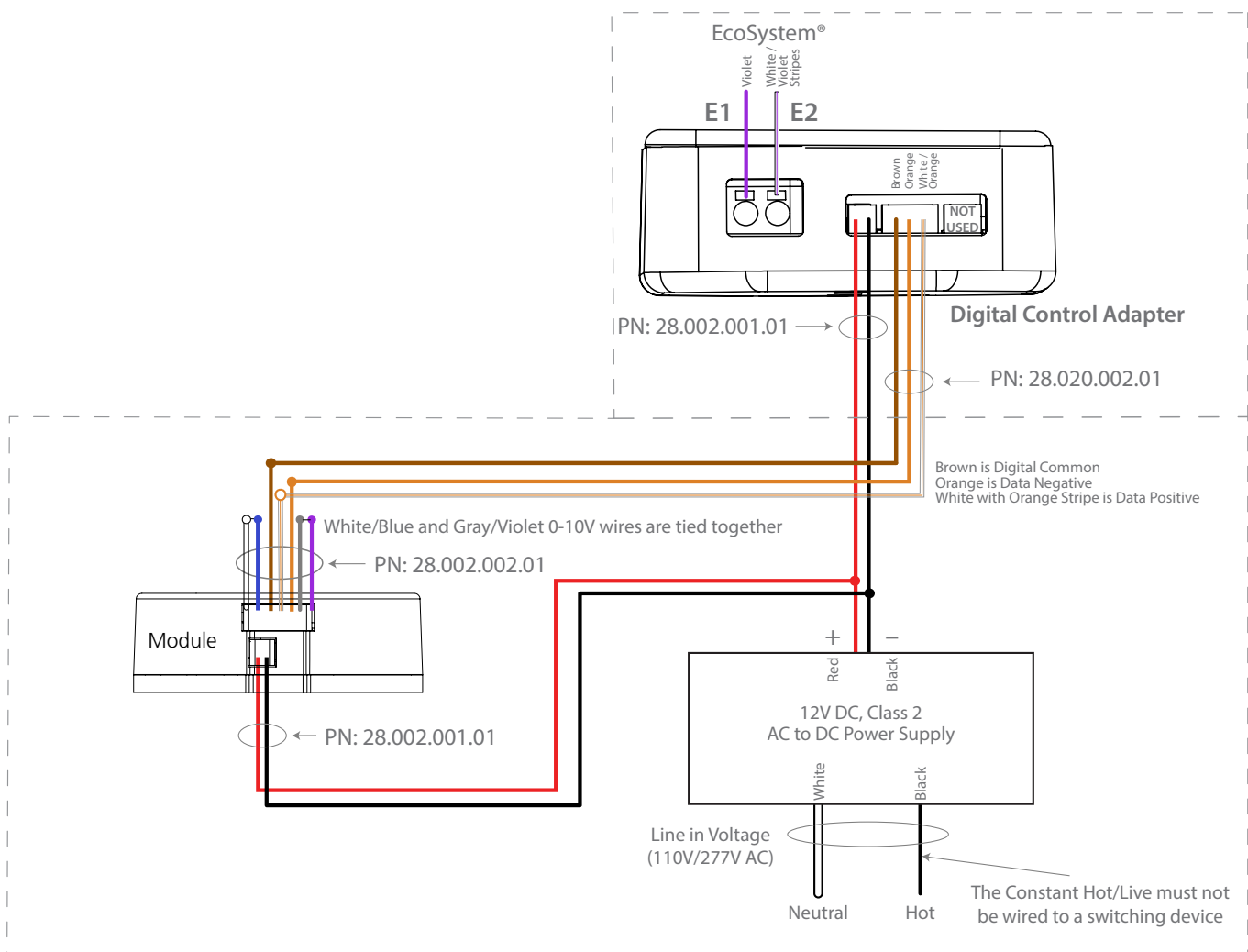

10 WIRING DIAGRAMS

10.3 DMX Input / Lux Output (12V DC) Digital Control Adapter

Notes:

1. 12V power (red/black) is Class-2 rated.
2. Module Data +/- (white with orange stripe/orange) to araya⁵ modules is Class-2 rated.
3. Adapter is configured at factory for DMX (including Bluetooth) inputs.
4. DCA may be installed in the luminaire or at the control system.
5. CAUTION: The power cable should ONLY be plugged into the 2-pin power receptacle provided. Insertion of the cable into any other slot will damage the Digital Control Adapter unit.

