

12 WIRING DIAGRAMS

12.1 0-10V Wiring Diagram

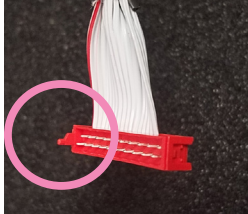

INDEX TAB ON RED END OF CABLE CONNECTOR SHOULD LINE UP WITH INDEX SLOT ON ALM.

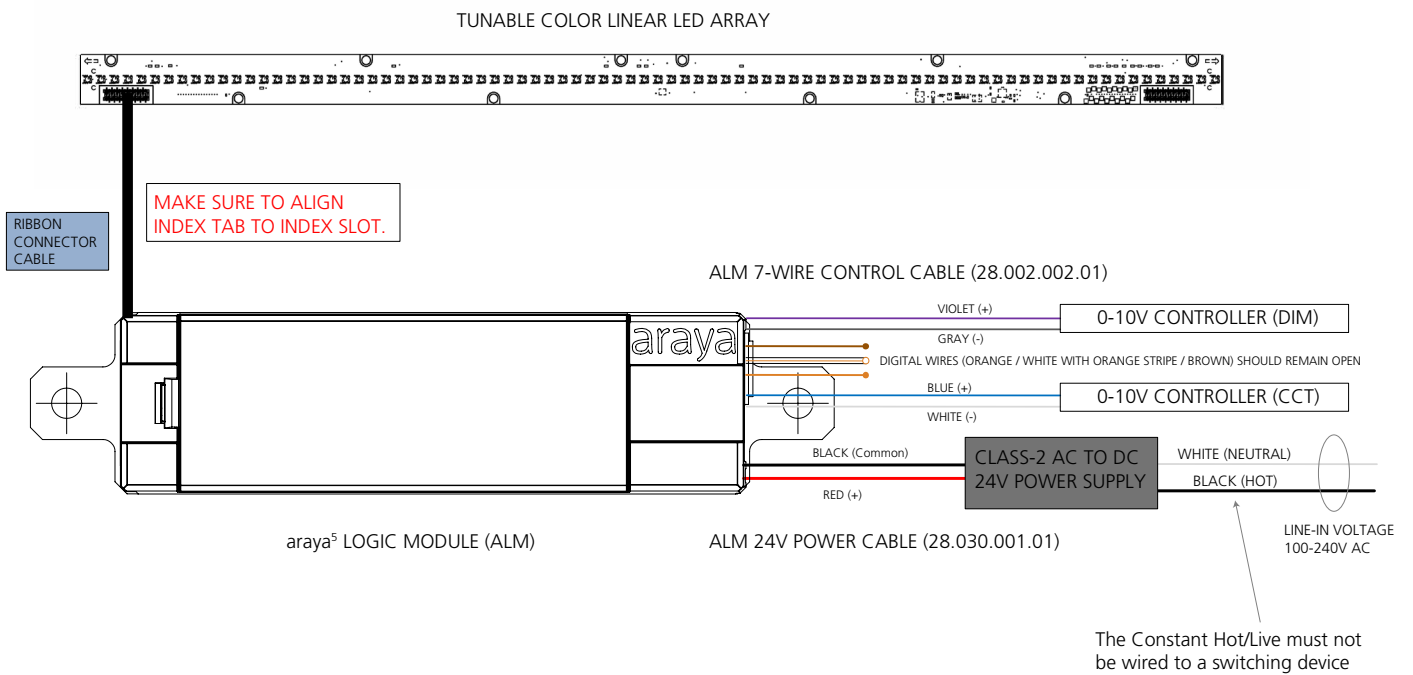

12 WIRING DIAGRAMS

12.2 Bluetooth Operation using the araya⁵ Tunable Color 2.0 iOS App

TUNABLE COLOR 2.0 iOS APP

(MAX. OF 8 MODULES CAN BE CONTROLLED AT A TIME)

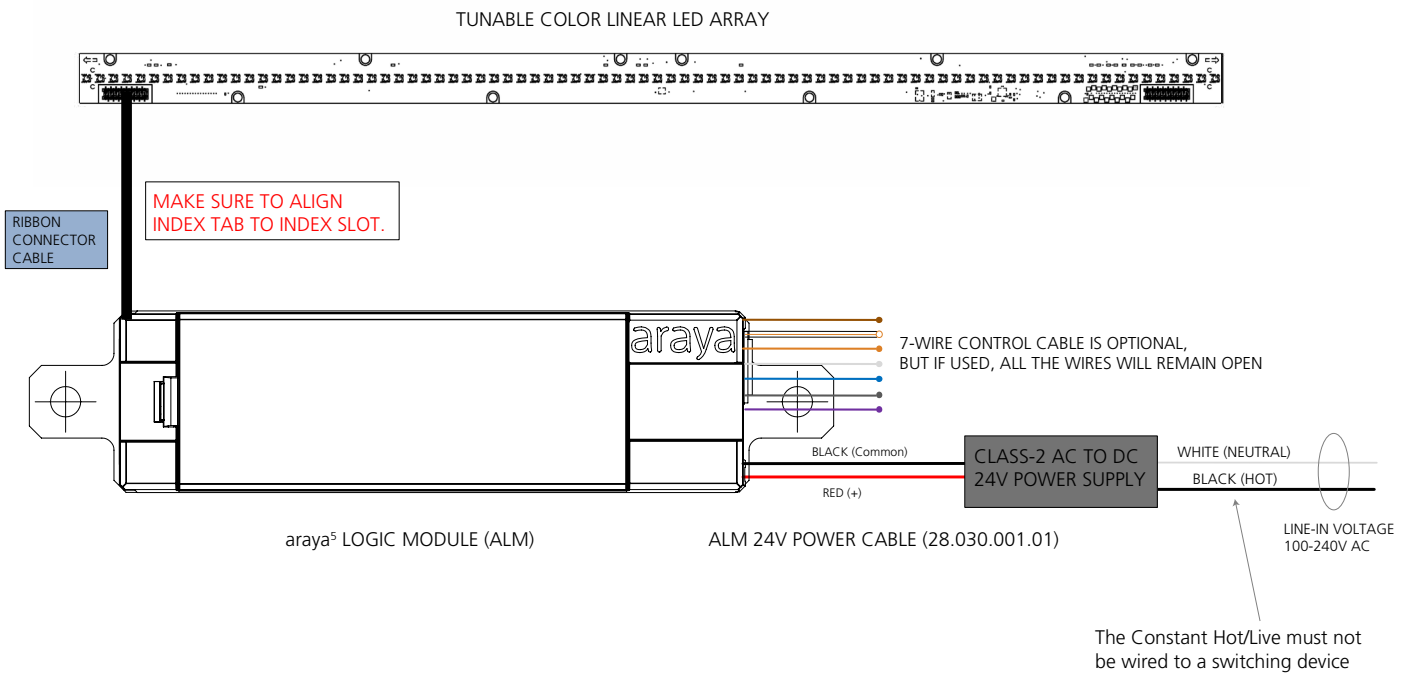

12 WIRING DIAGRAMS

12.3 DMX512-A Protocol

DMX512-A is an acronym for Digital Multiplex, a communication protocol used to remotely control lighting dimmers and intelligent fixtures. It is designed to provide a common communications standard between these lighting devices regardless of the manufacturer. The 512-A after the DMX refers to the number of control channels used on one network segment (often called a 'universe') of devices. In a simple dimming system, one channel controls the intensity of the fixture. A single intelligent fixture such as the araya⁵ requires several channels to control its various parameters (one channel each for DIM, CCT, SAT, HUE).

DMX512A Specifications:

- DMX 512-A (Controller).
- A universe is 512 Channels.
- DMX value is between 0 and 255, where 0 is off and 255 is full on.
- The maximum number of devices in a daisy-chain wire run is 32, which include the controller and opto-splitter.
- The maximum network wire run is a distance of up to 1600 feet for non-RDM systems and up to 1000 feet for RDM systems.
- One device functions as the master (DMX controller) on a network, while the rest function as slaves (mergers, splitters, intelligent fixtures, etc.).
- Only the controller (master) transmits over the network, and all fixtures receive the same data.
- The final device in the daisy-chain must be terminated with a 120 ohm resistor between DMX+ and DMX- pins.
- All wiring must be in a continuous run and daisy-chained.
- Star wiring is only allowed in conjunction with an opto-splitter.
- Do not run DMX control cable in close proximity to AC power lines. EM spikes from switching of high-current devices such as HVAC equipment or generators will induce noise into the DMX cable.
- The shield must be carried through between modules and properly grounded at one point only.
- Connections to DMX512-A-RDM accessory board: wire size to be 24AWG, and solid or stranded cables may be used. Stranded wire used must be tinned or installed with ferule connector.

RDM

DMX512-A control protocol that enables Remote Device Management for two-way communications for configuration, monitoring and system setup. Allows two way communication between lighting controller and the fixtures. Allows for remote setting of DMX start addressing. RDM signals are sent back the other way, but not constantly. Controller can ask one or more devices for query feedback. RDM packets are inserted in-between the existing DMX data packets being used to control the lighting. The DMX Control Console will broadcast up to 512 channels over one DMX cable (max. run of 1000 feet for RDM). Some of these channels may not be used, but will still be transmitted, as required by the protocol. It must be set to a desired channel (001, 002, 003, 004, etc.) to control the connected light fixture. This is usually accomplished using RDM. This desired 'channel' is commonly known as the DMX address. When addressing fixtures, it is not recommended to skip addresses.

When RDM is not available with the control system, it is permissible to use the Lumenetix commissioning tool (the araya⁵ Tunable Color 2.0 iOS App) to set the address of the slots. The instructions to configure the DMX channels can be found in the separate araya⁵ Tunable Color Instruction Manual.

The DMX512-A interface follows the ANSI E1.11-2008 (R21013) standard. Four address slots are allocated to each interface board and control the Dim level, CCT, Saturation and Hue of the araya⁵ modules connected to the board.

Default DMX512-A Slot Allocation:

Slot	Function
1	Dim Level
2	CCT
3	Saturation Level
4	Hue

12 WIRING DIAGRAMS

12.3.1 DMX512-A Electrical Specifications

Parameter	Range	Remarks
Receiver type	Isolated	
ESD Protection	±15KV (air), ±8KV (conducted)	Per IEC 61000-4-2
Termination	Recommended	The DMX512 bus termination rules apply
Directionality	Receive only	
Frequency stability	±20ppm	
Load per port	1/256	1/8 of Nominal RS-485
Isolation	3KV _{rms}	

DMX512-A Control Systems (recommended list)

Choreo
 Cognito
 Crestron Greenlight System
 Entec
 ETC Mosaic
 ETC Paradigm
 Fresco
 Lutron HomeWorks QS
 Lutron Quantum
 Pathway Connectivity
 Pharos
 Traxon Ecue
 Vantage Controls

*Recommendations are subject to change. Consult your Lumenetix representative for the most updated list.

12 WIRING DIAGRAMS

12.3.2 DMX512-A Recommended Field Wiring

Liberty 24-2P-485 (Non-Plenum), 24 AWG, 2 pair dual 120 ohm, 11.2 pf/ft low capacitance (XLR and PHX connectors)
 Liberty 24-2P-P485 (Plenum), 24 AWG, 2 pair dual 120 ohm, 11.2 pf/ft low capacitance (XLR and PHX connectors)
 Belden #9842 (Non-Plenum), 24 AWG, 2 pair dual shielded 120 ohm, 12.8 pf/ft low capacitance (XLR and PHX connectors)
 Belden #89842 (Plenum), 24 AWG, 2 pair dual shielded 120 ohm, 12.8 pf/ft low capacitance (XLR and PHX connectors)

Please refer to wire manufacturer's lighting catalog for and>equals as required by code.

DMX512-A Recommended Field Connectors

Use only approved connectors.

DMX512-A Wiring Connections

Signal	Description	Pin Colors (4-Pair Cable)	Pin Colors (2-Pair Cable)	3-pin XLR connector	5-Pin XLR connector
Signal Common		White/Brown and Brown	White/Blue and Blue	1	1
Data (-)	Primary Data Link	Orange	Orange	2	2
Data (+)	Primary Data Link	White/Orange	White/Orange	3	3
Data2 (-), or not used	Optional Secondary Data Link				4
Data2 (+), or not used	Optional Secondary Data Link				5

XLR Connectors (5-Pin)

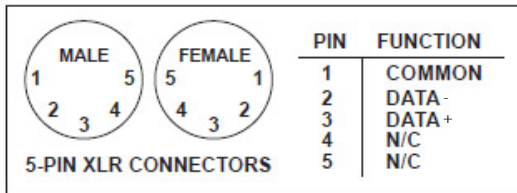

RJ-45 Connector Pin-Out (T568B)

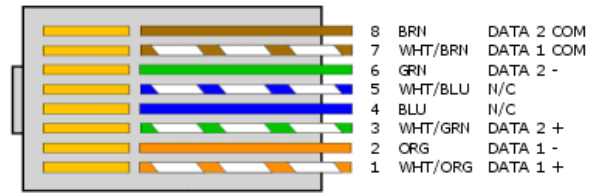

DMX512-A Controller Example

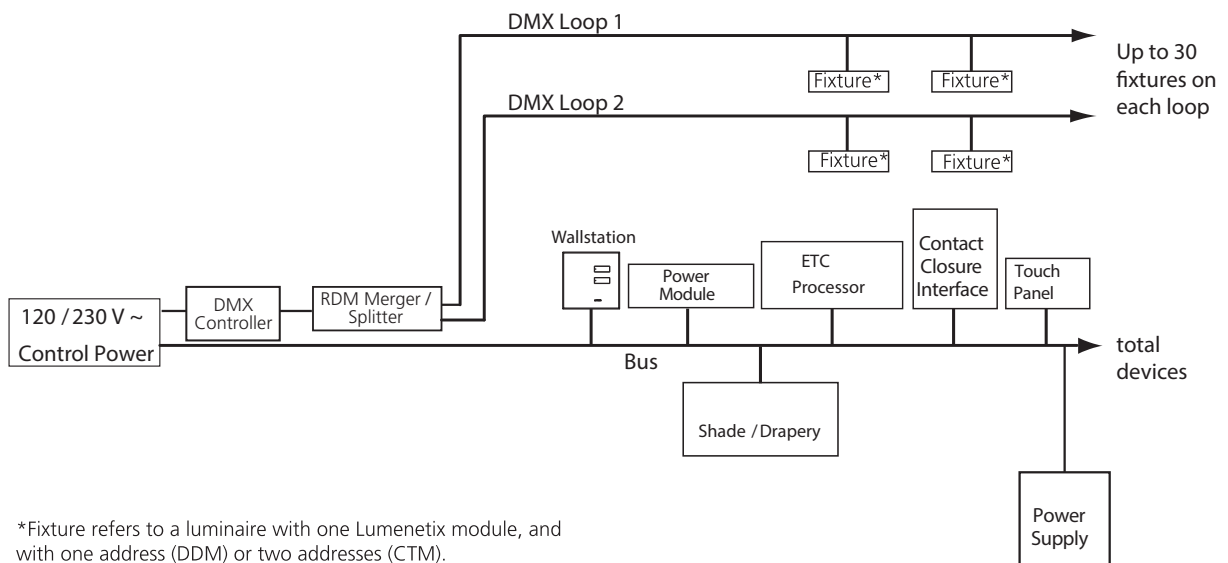

*Fixture refers to a luminaire with one Lumenetix module, and with one address (DDM) or two addresses (CTM).

12 WIRING DIAGRAMS

12.3.3 DMX512-A Drain Wire Connections

Drain wire connections are required as follows.

Shielding

To add another level of protection from electromagnetic noise, a grounded shield is added over the twisted pair wires. When this is enclosed in a protective jacket, to avoid ground loops and electromagnetic contamination of the ground system, all control ground wiring, including cable shields and drain wires, should be treated like sensitive current-carrying conductors. All control ground wires should be insulated (not bare) and the same wiring practices should be observed with ground wires as with other sensitive signals. Care must also be taken when designing control wiring to ensure that each shield is connected to only a single ground point. You should establish this point at a central location, like a control panel or cabinet, and avoid all connection to grounds in the field. A control ground is sometimes referred to as an isolated ground (an oxymoron) for this reason, but the term single-point ground is more accurate.

Method-1

A typical two-pair shielded cable can be prepared for termination to the terminals with the drain wire cut off. This is usually done at the field end of the cable where no shield grounding is desired. You will then use insulating tape or heat-shrink tubing to protect the cable from contamination and to prevent accidental grounding of the shield or drain wire. An accidental ground at this point would almost certainly create an undesirable ground loop.

Method-2

A typical two-pair shielded cable can be prepared for termination to the terminals with the drain wire cut off. The drain wire, which is an uninsulated conductor, is sleeved with a insulating tubing to prevent accidental grounding. The crimp-on lug is valuable in this instance to retain the tubing. Insulating tape or heat-shrink tubing is again used to protect the cable from contamination and to prevent accidental grounding, since any accidental connection between the drain wire and a chassis, frame, or enclosure would almost certainly create a ground loop.

12 WIRING DIAGRAMS

12.3.4 DMX512-A-RDM Accessory Card Wiring Diagram

Notes:

1. 24V power (red/black) is Class-2 rated.
2. Adapter is configured at factory for DMX inputs.

DMX SLOTS SET BY RDM OR BY TUNABLE COLOR 2.0 iOS APP

(MAX. OF 8 MODULES CAN BE CONTROLLED AT A TIME)

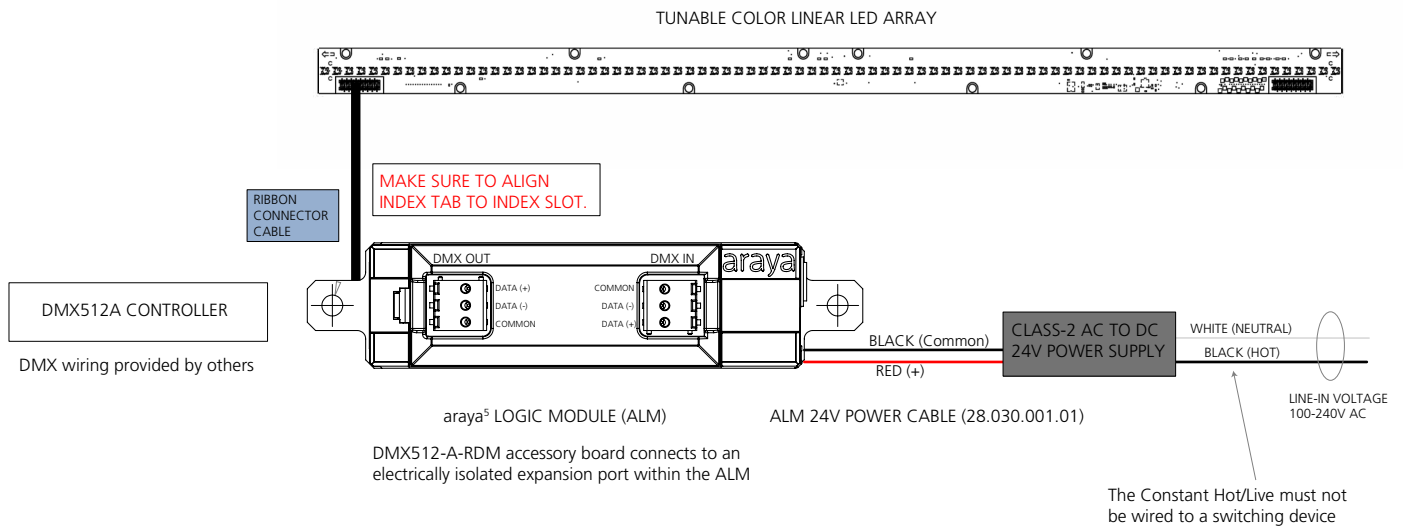

12 WIRING DIAGRAMS

12.4.1 Eco Wiring

- EcoSystem Digital Loop can be wired as Mains voltage or IEC PELV/NECR Class 2 for maximum wiring flexibility..
- The Loop is polarity insensitive and can be wired in any topology..
- Consult all national and local electrical codes for separation requirements..

Wire Gauge	Maximum EcoSystem-Compliant Loop Wire Length
4.0 mm ² (12 AWG)	671 m (2200 ft)
2.5 mm ² (14 AWG)	427 m (1400 ft)
1.5 mm ² (16 AWG)	275 m (900 ft)
1.0 mm ² (18 AWG)	175 m (570 ft)

12.4.2 Drain Wire Connections

Drain wire connections are required as follows.

Shielding

To add another level of protection from electromagnetic noise, a grounded shield is added over the twisted pair wires. When this is enclosed in a protective jacket, to avoid ground loops and electromagnetic contamination of the ground system, all control ground wiring, including cable shields and drain wires, should be treated like sensitive current-carrying conductors. All control ground wires should be insulated (not bare) and the same wiring practices should be observed with ground wires as with other sensitive signals. Care must also be taken when designing control wiring to ensure that each shield is connected to only a single ground point. You should establish this point at a central location, like a control panel or cabinet, and avoid all connection to grounds in the field. A control ground is sometimes referred to as an isolated ground (an oxymoron) for this reason, but the term single-point ground is more accurate.

Method-1

A typical two-pair shielded cable can be prepared for termination to the terminals with the drain wire cut off. This is usually done at the field end of the cable where no shield grounding is desired. You will then use insulating tape or heat-shrink tubing to protect the cable from contamination and to prevent accidental grounding of the shield or drain wire. An accidental ground at this point would almost certainly create an undesirable ground loop.

Method-2

A typical two-pair shielded cable can be prepared for termination to the terminals with the drain wire cut off. The drain wire, which is an uninsulated conductor, is sleeved with a insulating tubing to prevent accidental grounding. The crimp-on lug is valuable in this instance to retain the tubing. Insulating tape or heat-shrink tubing is again used to protect the cable from contamination and to prevent accidental grounding, since any accidental connection between the drain wire and a chassis, frame, or enclosure would almost certainly create a ground loop.

12 WIRING DIAGRAMS

12.4.3 Lutron[®] EcoSystem Accessory Card Wiring Diagram

Notes:

1. 24V power (red/black) is Class-2 rated.
2. EcoSystem Channel 1 is always Intensity Level. EcoSystem Channel 2 is always CCT Preset.
3. In the EcoSystem programming mode, EcoSystem Channel 1 (Intensity Level) will cycle through the dimming range (100%-1%) to identify channel. EcoSystem Channel 2 (CCT Preset) will cycle through the CCT range of the module to identify channel.

