

10 RIBBON CABLE ASSEMBLIES

10.1 Flat 16-Pin Ribbon Cable (Nominal 8" Length)

Lumenetix part #:
 28.031.001.04

16-pin Tyco connectors at each end; for connecting 1 ft. linear boards to each other.

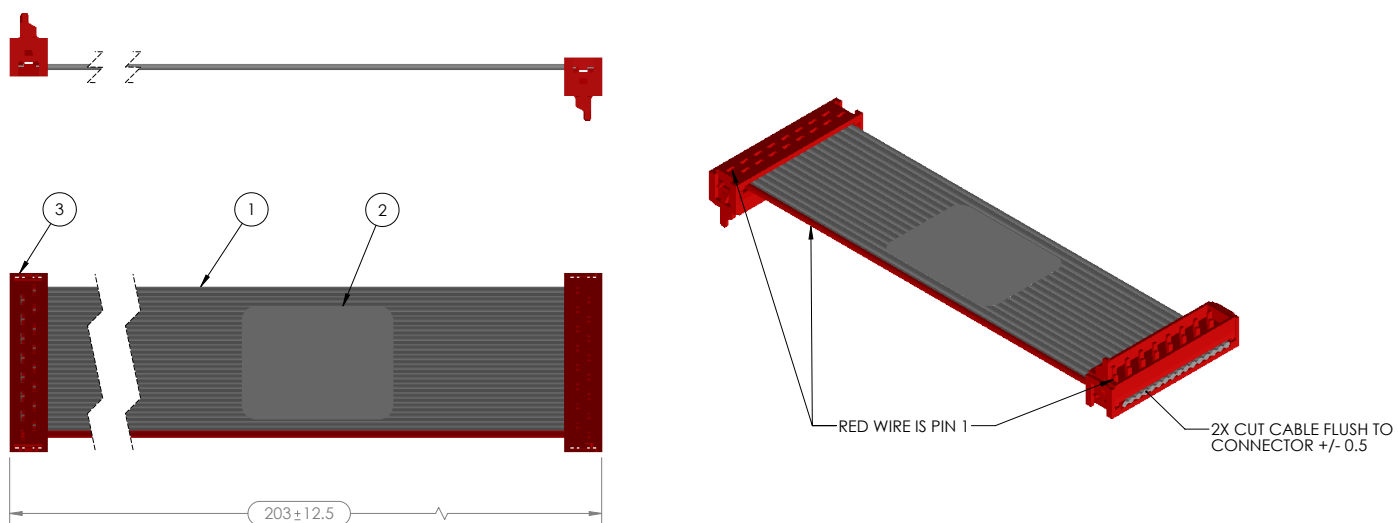

Note: All dimensions are in millimeters.

ITEM NO.	PART NUMBER	QTY.
1	16 PIN RIBBON CABLE 3M 3365-16	1
2	LABEL, LUMENETIX, PART#, DESCRIPTION, REVISION	1
3	16 PIN CONNECTOR 1-215083-6	2

10 RIBBON CABLE ASSEMBLIES

10.2 Flat 16-Pin Ribbon Cable (Nominal 24" Length)

Lumenetix part #:
 28.030.002.02

16-pin Tyco connectors at each end; for connecting ALM to 1 linear board.

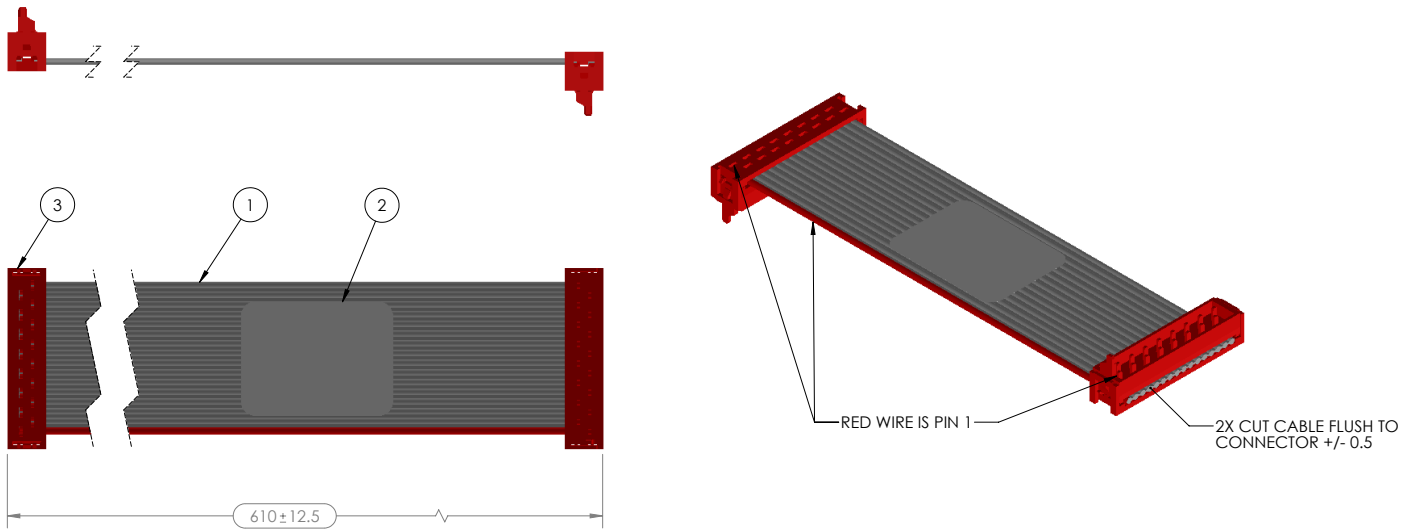

Note: All dimensions are in millimeters.

ITEM NO.	PART NUMBER	DESCRIPTION	QTY.
1	16 PIN RIBBON CABLE	3M 3365/16 PIN PVC RIBBON CABLE	1
2	LABEL	LUMENETIX, P/N, DESCRIPTION, REVISION	1
3	16 PIN CONNECTOR c-1-215083-6-t-3d	CONNECTOR 16 PIN 1-215083-6	2

10 RIBBON CABLE ASSEMBLIES

10.3 Flat 16-Pin Ribbon Cable (Nominal 32" Length)

Lumenetix part #:
 28.031.001.01

16-pin Tyco connectors at at 0", 24" and 32"; for connecting ALM to 2 linear boards.

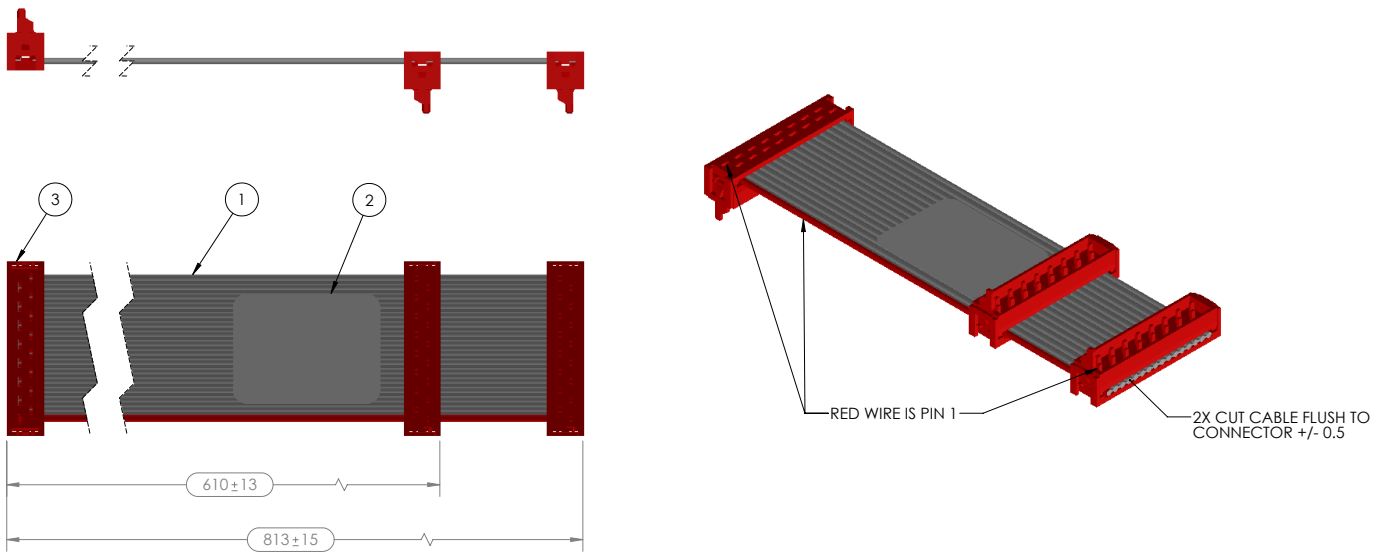

Note: All dimensions are in millimeters.

ITEM NO.	PART NUMBER	DESCRIPTION	QTY.
1	16 PIN RIBBON CABLE	3M 3365/16 PIN PVC RIBBON CABLE	1
2	LABEL	LUMENETIX, P/N, DESCRIPTION, REVISION	1
3	16 PIN CONNECTOR c-1-215083-6-t-3d	CONNECTOR 16 PIN 1-215083-6	3

10 RIBBON CABLE ASSEMBLIES

10.4 Flat 16-Pin Ribbon Cable (Nominal 44" Length)

Lumenetix part #:
 28.031.001.02

16-pin Tyco connectors at -20", -12", 0", and 24"; for connecting ALM to 3 linear boards.

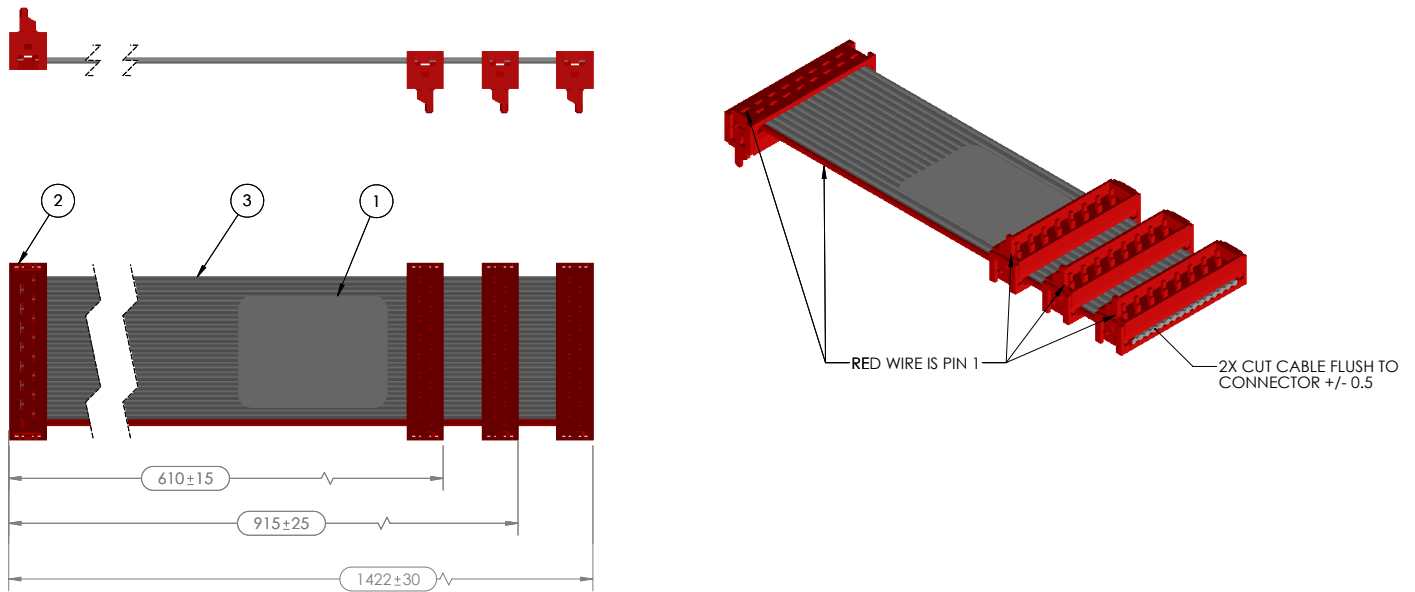

Note: All dimensions are in millimeters.

ITEM NO.	PART NUMBER	QTY.
1	LABEL, LUMENETIX, PART#, DESCRIPTION, REVISION	1
2	16 PIN CONNECTOR 1-215083-6	4
3	16 PIN RIBBON CABLE 3M 3365-16	1

10 RIBBON CABLE ASSEMBLIES

10.5 Flat 16-Pin Ribbon Cable (Nominal 68" Length)

Lumenetix part #:
28.031.001.03

16-pin Tyco connectors at -34", -26", 0", 26" and 34"; for connecting ALM to 4 linear boards.

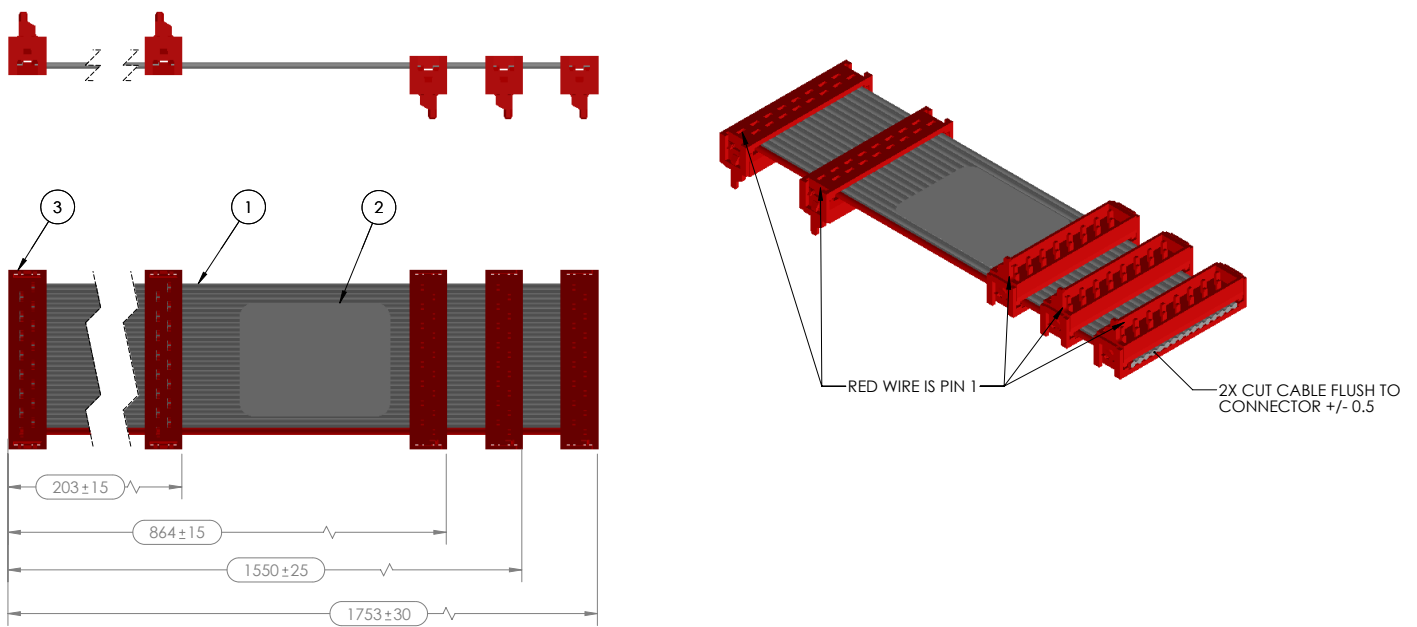

Note: All dimensions are in millimeters.

ITEM NO.	PART NUMBER	DESCRIPTION	QTY.
1	16 PIN RIBBON CABLE	3M 3365/16 PIN PVC RIBBON CABLE	1
2	LABEL	LUMENETIX, P/N, DESCRIPTION, REVISION	1
3	16 PIN CONNECTOR c-1-215083-6-t-3d	CONNECTOR 16 PIN 1-215083-6	5