

8 CASE TEMPERATURE MEASUREMENT POINTS

8.1 araya⁵ Logic Module (ALM) Case Temperature (T_c) Measurement Points

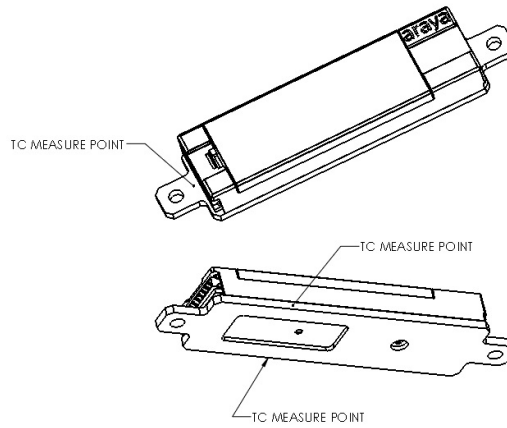

MAXIMUM CASE TEMPERATURE (T_c) FOR ALM: **70°C**

8.2 Linear LED Array Case Temperature (T_c) Measurement Point

1' Linear Array

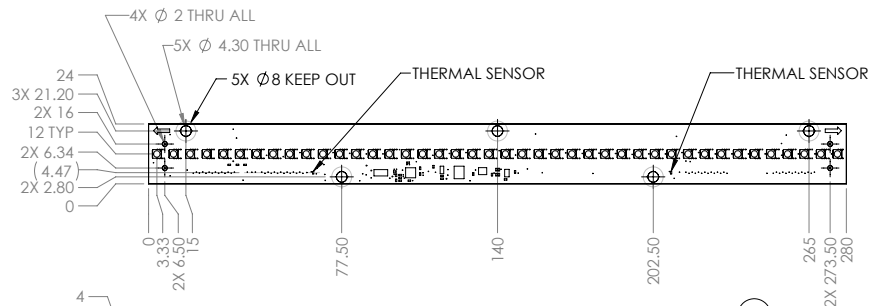

2' Linear Array

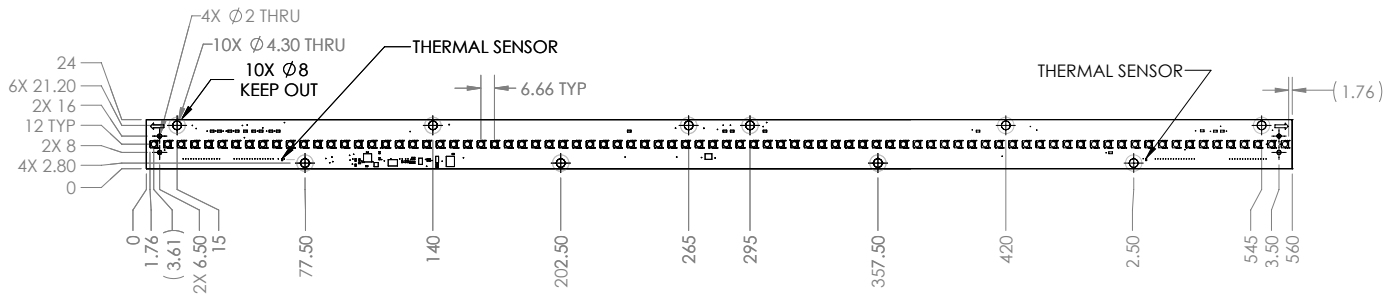

T_c Measurement Point is adjacent to Thermal Sensor.

MAXIMUM T_c FOR LINEAR LED ARRAY: **60°C**